

# M K 8 8

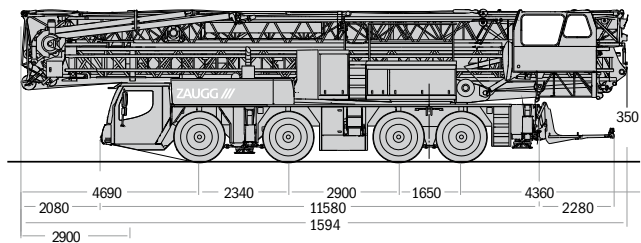

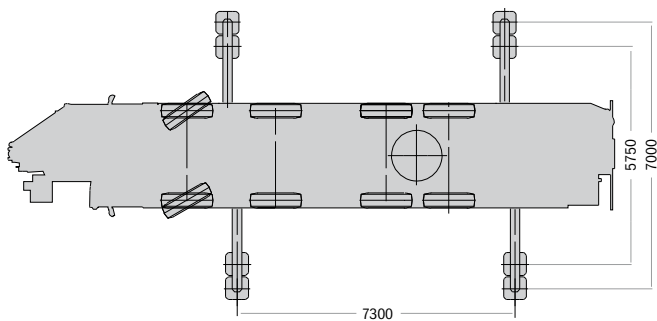



Gewicht 48 t  
Zusatzausrüstung Funksteuerung,  
Auslegerbeleuchtung,  
Auslegerkamera

**8 t**





## Ausladung und Tragfähigkeit







	m	m/t 	m/t																	
7.30 x 7.00			12.0	14.0	16.0	18.0	20.0	22.0	24.0	26.0	28.0	30.0	32.0	34.0	36.0	38.0	40.0	42.0	44.0	45.0
 max. 6.5 Bft (14 m/sec.)	45.0	3.3-11.0 8.0	7.4	6.4	5.6	5.0	4.5	4.1	3.7	3.4	3.1	2.9	2.7	2.5	2.4	2.3	2.1	2.0	1.9	1.9
 max. 8.0 Bft (20 m/sec.)	45.0	3.3-10.0 8.0	6.8	5.9	5.1	4.6	4.1	3.7	3.4	3.1	2.9	2.7	2.5	2.4	2.2	2.0	2.0	1.8	1.8	1.7

## Auslegersteilstellung



	m	m/t 	m/t Auslegersteilstellung 30°																
7.30 x 7.00			8.0	10.0	12.0	14.0	16.0	18.0	20.0	22.0	24.0	26.0	28.0	30.0	32.0	34.0	36.0	38.9	
 max. 6.5 Bft (14 m/sec.)	45.0	3.3-10.0 6.0	6.0	6.0	5.3	4.7	4.2	3.8	3.5	3.2	3.0	2.8	2.6	2.4	2.3	2.1	2.0	1.9	
 max. 8.0 Bft (20 m/sec.)	45.0	3.0-8.0 6.0	6.0	5.2	4.6	4.1	3.7	3.3	3.1	2.8	2.6	2.4	2.2	2.1	2.0	1.9	1.7	1.6	

	m	m/t Auslegersteilstellung 15° 		m/t Auslegersteilstellung 45° 	
		m	t	m	t
7.30 x 7.00					
 max. 6.5 Bft (14 m/sec.)	45.0	3.2-38.0 38.0-43.3	1.9 1.9-1.6	2.7-31.9	1.9
 max. 8.0 Bft (20 m/sec.)	45.0	3.2-32.0 32.0-43.3	1.9 1.9-1.3	2.7-28.0 28.0-31.9	1.9 1.9-1.6

Länge	11.58 / 15.94 m
Breite	2.75 m
Höhe	4.00 m
Schwenkradius	3.55 / 3.70 m
Abstützbreite	7.00 / 7.30 m
Gewicht	48 t

8 t

